

PUSH BUTTON

GBI

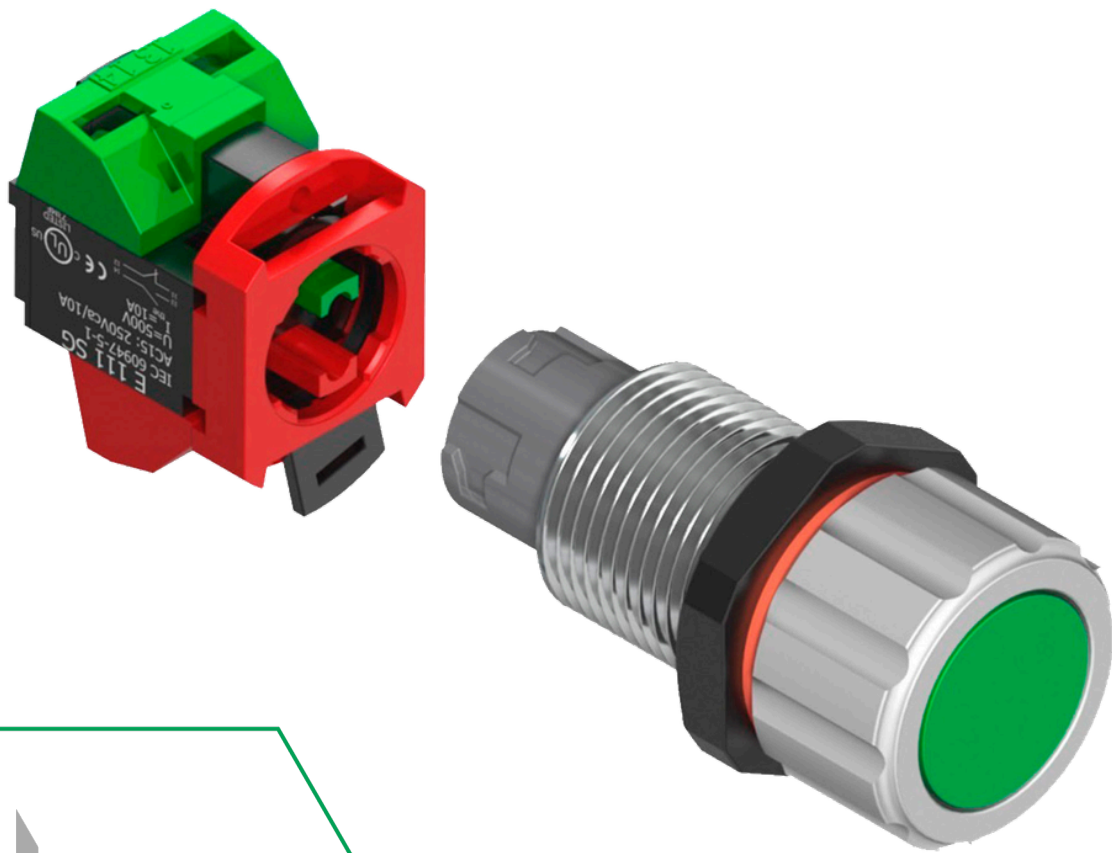





sermat **GRÜN**
ex

REV.24 / 12.03.2026

PUSH BUTTON

Technical Data

TECHNICAL SPECIFICATION

TYPE OF PROTECTION	Ex "d" – Flameproof Ex "t" – Dust ignition protection	Explosion proof Dust ignition proof	Ex "d" – Flameproof Ex "t" – Dust ignition protection
MARKING	Ex db IIC Gb Ex tb IIIC Db	Class I, Groups B, C, D Class II, Groups E, F, G Class III	II 2 G Ex db IIC / IIB +H2Gb II 2 D Ex tb IIIC Db
AREA OF APPLICATION	Zone 1 Zone 2 Zone 21 Zone 22	Class I, Div 1 & 2, Groups B, C, D. Class II, Div 1 & 2, Groups E, F, G. Class III	Zone 1 Zone 2 Zone 21 Zone 22
INGRESS PROTECTION	IP66W (W: salt spray)	Type 4X	IP66
TEMPERATURE RANGE	-50°C to 60°C (-40°F to 158°F)	-50°C to 60°C (-40°F to 158°F)	-50°C to 100°C (-40°F to 212°F)
THREAD SIZE	M22 x 1,5 3/4" NPSM	M22 x 1,5 3/4" NPSM	M22 x 1,5 3/4" NPSM
THREAD LENGTH	25mm (Normal) 40mm (Long) 57mm (Extra Long)	25mm (Normal) 40mm (Long) 57mm (Extra Long)	25mm (Normal) 40mm (Long) 57mm (Extra Long)
INSTALLATION	for M22x1,5 THREAD in Ex "d" enclosures : (min. wall thickness : 8 mm engaged thread) in Ex "tb" enclosures : (min. wall thickness : 3 mm engaged thread)	for M22x1,5 THREAD in Ex "d" enclosures : (min. 6 fully engaged threads) in Ex "tb" enclosures : (min. 3 fully engaged threads)	for M22x1,5 THREAD in Ex "d" enclosures : (min. wall thickness : 8 mm engaged thread) in Ex "tb" enclosures : (min. wall thickness : 3 mm engaged thread)t
	for 3/4"NPSM THREAD in Ex "d" enclosures : (min. 5 fully engaged threads) in Ex "tb" enclosures : (min. wall thickness : 3,7 mm engaged thread)	for 3/4"NPSM THREAD in Ex "d" enclosures : (min. 7 fully engaged threads) in Ex "tb" enclosures : (min. 3 fully engaged threads)	for 3/4"NPSM THREAD in Ex "d" enclosures : (min. 5 fully engaged threads) in Ex "tb" enclosures : (min. wall thickness : 3,7 mm engaged thread)
CERTIFICATE OF COMPLIANCE	Segurança  OCP 0034  INMETRO	 UL LISTED	  ATEX I IECEx
	INMETRO NCC 24.0128 U	UL UL: E489210	ATEX I IECEx UL 21 ATEX 2390U IECEx ULBR 21.0004U

PUSH BUTTON

Technical Data

ELECTRICAL INFORMATION

CONTACT BLOCKS INFORMATION		
RATED VOLTAGE	Ui 500V	
RATED CURRENT	Ith 10A	
CONTACTS FOR AC 15	VOLTAGE	CURRENT
	220V	10A
	380V	7,5A
	500V	5A
CONTACTS FOR DC 13	VOLTAGE	VOLTAGE
	24V	2,75A
	60V	1,10A
	110V	0,55A
	220V	0,27A

DIMENSIONS

X	
mm	inch
25mm	≈ 1"
40mm	≈ 1.19/32"
57mm	≈ 2.1/4"

M22 X 1,5

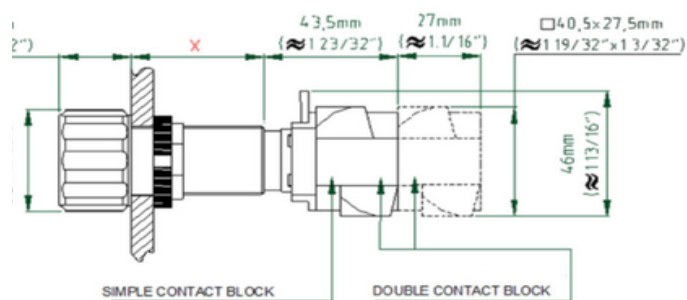

3/4"NPSM

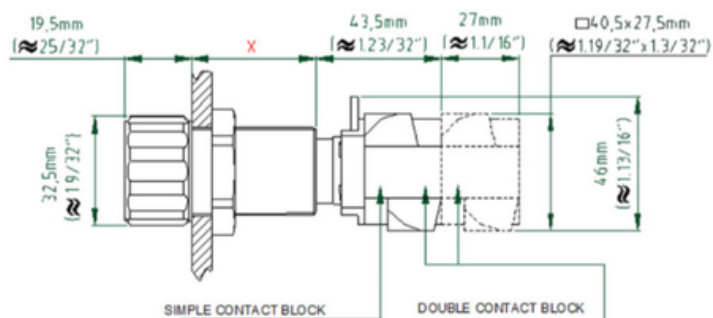

PUSH BUTTON

Ordering Code

ORDERING CODE

SGEXXGBI **A + B + C**

X

THREAD SIZE

size	M22x 1,5	3/4"NPSM
code	22	26

A

THREAD LENGTH

length	25mm	40mm	57mm
code	N	L	X

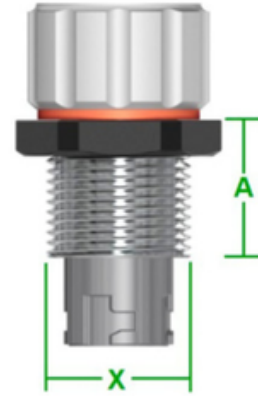

B

COLOR



color	Blue	Yellow	Red	Green	White	Black
code	AZ	AM	VM	VD	BR	PR

C

CONTACT BLOCKS

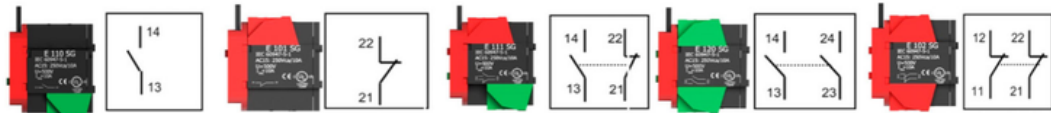

	NO	NC	NONC	2NO	2NC
code	10	01	11	20	02

SPECIAL CONTACT BLOCK

DOUBLE CONTACT BLOCKS



	1NO3NC	4NC	4NO	3NO1NC	2NO2NC
code	13	04	40	31	22

CONTACT BLOCKS WITH RETENTION

FUNCTION:
Push-on, Push-off







	NO (w/ retention)	NC (w/ retention)	NONC (w/ retention)	2NO (w/ retention)	2NC (w/retention)
code	10R	01R	11R	20R	02R

PUSH BUTTON

Codification Examples & Accessories

CODIFICATION EXAMPLES

	+	3/4NPSM LENGTH 25MM	+		+		=	SGEX26GBINVMO1
SGEX26GBI		N		VM		01		
	+	M22x1,5 LENGTH 25MM	+		+		=	SGEX22GBINVDI0
SGEX22GBI		N		VD		10		

ACCESSORIES

IDENTIFICATION PLATE (only for M22x1,5 thread)



CODE	S2PL1		
PRINTABLE AREA	15,4x27,20		
G00	LIGA	G05	STOP
G01	DESLIGA	G06	RESET
G02	ABRE	G07	OPEN
G03	FECHA	G08	CLOSE
G04	START	G09	

DIMENSIONS (mm)

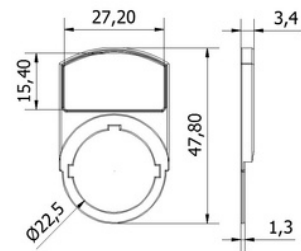

IDENTIFICATION PLATE (only for 3/4"NPSM)



CODE	S3PL3		
ÁREA P/ INSCRIÇÃO	19,3x33,3		
G00	LIGA	G05	STOP
G01	DESLIGA	G06	RESET
G02	ABRE	G07	OPEN
G03	FECHA	G08	CLOSE
G04	START	G09	

DIMENSIONS (mm)

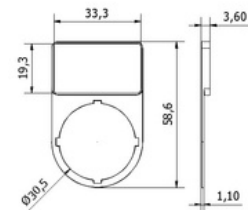

LOCK FOR PRESSED POSITION (for 3/4 NPSM or M22x1,5 thread)



CODE E-TRAVA-CM

The E-TRAVA-CM allows the button to be locked in the pressed position.

DIMENSIONS (mm)

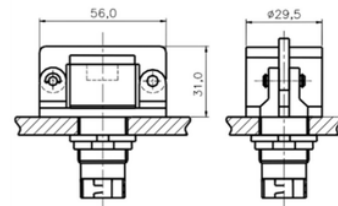

BUTTON LOCK (for 3/4 NPSM or M22x1,5 thread)



CODE E-TRAVA-SM

The E-TRAVA-SM prevents the button from being pushed.

DIMENSIONS (mm)

